

Window Cleaning Robot

User Manual – Glider



Thank you for purchasing this product,
please read the manual carefully before using it.

Content

1. Important safety matters and warnings	02
2. Product Description & Parameters	04
3. Use Step	06
4. Cleaning Function	08
5. Remote control	10
6. Voice assistance function	11
7. Tuya App Operation Guide	12
8. Product Maintenance	14
9. Troubleshooting	16

1. Important safety matters and warnings

1. Attention! Must read before use

1. Do not allow children to operate this product. Users with physical, sensory or psychological disorders, or those who lack knowledge of the functions and operation of this product must be supervised by a fully competent user after being familiar with the use procedures and safety risks. Users must use the product under the supervision of a fully capable user after familiarizing themselves with the use process and safety risks. Children should not use. This product should not be used by children as a toy.
2. This product is used to clean framed glass and without frames. If the window or glass frame has a damaged silicone rubber edge, please be sure to pay special attention to prevent the machine will leak and fall off during the cleaning process. User must observe the using scenario to ensure that the product is used safely and securely when using on glass without frames

2. Safety matters

- Please use the original adapter! (Using a non-original adapter may cause product failure or damage the product.)
- Make sure the adapter has enough space for ventilation and heat dissipation during use. Do not wrap the power adapter with other objects.
- Do not use the adapter in a humid environment. Please do not touch the power adapter with wet hands during use.
- Please charge the window cleaner at the voltage that the power adapter can withstand.
- Do not use a damaged power adapter, charging cable or power plug. Before cleaning and maintaining the machine, the power plug must be unplugged and do not disconnect the power by unscrewing the extension cord to prevent electric shock.
- Do not disassemble the power adapter; if the power adapter is faulty, replace the entire power adapter. For assistance and repair, contact your local customer service or distributor.
- This product battery if not handled properly, there is a risk of combustion or chemical discretion injury to the body. Please do not disassemble the battery, so as not to cause a short circuit. Please do not use in fire and high temperature environment above 60°C.
- Please hand over the used battery to the local professional waste battery product recycling center for recycling, the disposal and recycling of used batteries must comply with national laws and regulations.
- Please strictly follow this manual to use this product.
- Please keep this manual for future use.
- Do not immerse this product in liquids (such as beer, water, drinks, etc.) or leave it in a humid environment for a long time.
- Do not expose this product to sunlight and keep this product away from heat sources (such as radiators, heaters, microwave ovens, gas stoves, etc.).
- Do not place this product in a strong magnetic scene.
- Please store this product out of reach of children.
- Please use this product in 0°C–40°C (32°F–104°F) ambient temperature.
- Do not clean damaged glass and objects with uneven surface, this product will not produce enough vacuum suction adsorption on uneven surface or damaged glass machine.
- The built-in battery of this product can only be replaced by the manufacturer or designated dealer / after sales center to avoid danger.
- Before removing the battery or handling the battery, the power must be disconnected.
- Please operate this product in strict accordance with the instructions, if any property damage and personal injury caused by improper use, the manufacturer will not be held responsible

Attention

1. Before use, please make sure that the safety rope is not damaged and one end is firmly connected to the machine. The other end should be securely attached to other objects in the room to prevent the Window Cleaning Robot from falling .
2. If the window glue is falling off in the middle section or chipped at the corners due to aging, please be careful to use the machine and make sure it is working during the working period. and make sure that there is a user supervising.

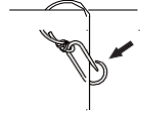

3. Risk of electric shock

- Make sure the power is completely disconnected and the machine is off before cleaning the body or maintaining the body.
- Do not drag the power plug through the extension cord, power off should be properly unplugged.
- Do not continue to use the product if the machine is damaged/the power supply is damaged.
- If the Machine is damaged, please contact your local after-sales center or dealer for repair.
- Do not use water to clean the machine body and power adapter.
- Do not use this product in dangerous areas such as open fire, bathroom with water flowing from the open nozzle, by the swimming pool, etc.
- Do not damage or twist the power cord. Do not put heavy objects on the power cord or adapter to avoid damage.

4. Warnings

1. Before operation, make sure to attach the safety rope and tie it securely to a stable indoor unit.
2. Before turning on the machine, check the safety rope for damage and secure knotting. Make sure there is no damage and that the knot is secure before using the product.
3. When cleaning the glass of a window or door without a blocking table, please set up a safety warning area downstairs.
4. Fully charge the built-in backup battery before use (green light on).
5. Do not use in rainy or wet weather.
6. Turn on the machine first and then place it on the window glass.
7. Make sure the machine is safely attached to the window surface before releasing your hands.
8. Before turning off the machine, please hold the machine to avoid dropping it.
9. Do not use this product to clean frameless windows or glass .
10. Make sure the cleaning cloth is properly attached to the bottom of the machine to prevent air leakage when the window cleaner is absorbed.
11. Do not spray the machine or the bottom of the machine. spray water only on the cleaning cloth.
12. Do not allow children to use the machine.
13. Please remove any items on glass surface before use.
14. Please ensure hair, loose clothes, fingers or other parts of body keep distance with the working parts of machine.
15. Do not use the machine in areas of flammable and explosive solids or gases.

2. Product Description & Parameters

1. product mix

1. The window cleaning robot is equipped with two water holes. When the machine is cleaned to the left, the left side will spray water automatically, and when the machine is cleaned to the right side, the right side will spray water automatically. A true empty motor makes the machine absorbed on the glass surface and walk freely on the vertical glass surface. Built-in uninterruptible power supply system (backup battery) can prevent equipment from falling due to power failure.
2. The robot has artificial intelligence, which can be voice-assisted, path planning, border and no frame detection, and automatically clean the whole window. Wireless remote control / APP can freely control the robot.

2. Product specification

Input voltage	AC100-240V 50Hz / 60Hz
Rated power	72W
Built-in battery	650mAh
Suction force	2500Pa
Net weight	1300g
Power outage protection time	40min
Noise	≥ 65dB
Control mode	Remote or smartphone APP
Edge detection	Automatic
Anti-fall control	UPS (uninterrupted power supply system) / safety rope
Cleaning mode	Manual / Auto
Water spraying method	Manual / Auto
External dimensions	216 x 216 x 73.2mm

3. Product component name

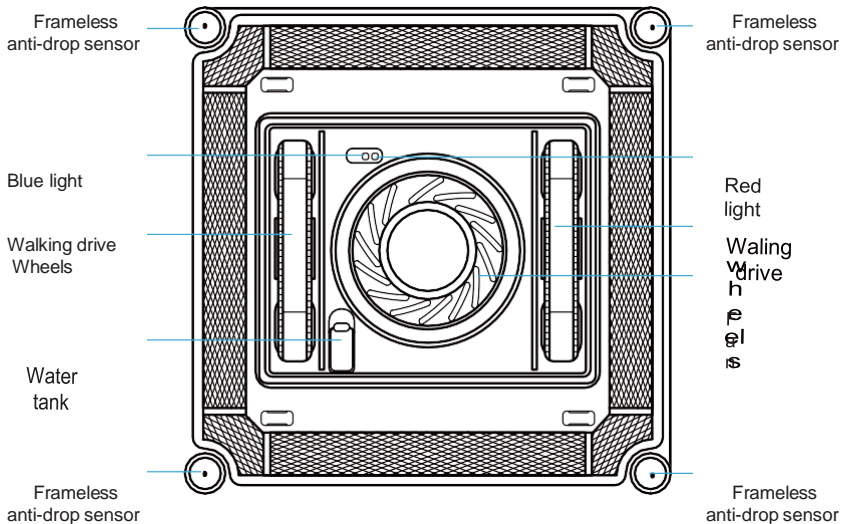
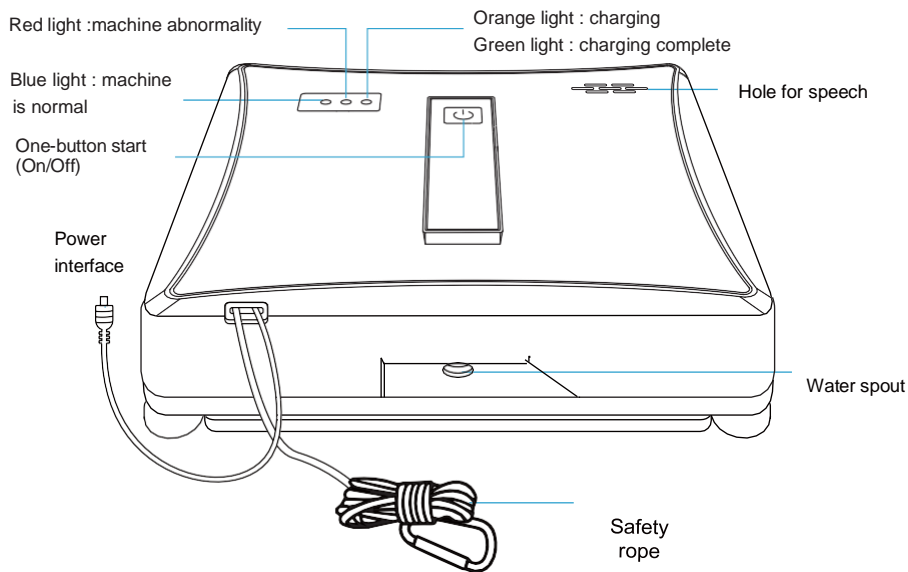

4. Packing list

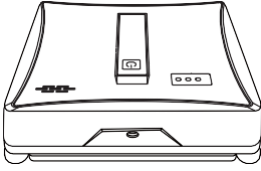

Host

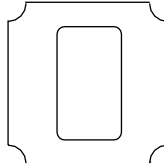

Cleaning pad



Adapter + power cord



Adding water bottle



Safety rope



Remote control



User Manual

3. Use Step

1. Install cleaning cloth

Attach the rag to the bottom of the fuselage correctly, making sure not to block the drive wheel and the anti-drop sensor. (Figure1, Figure2, Figure3)

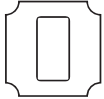

Clean cloth

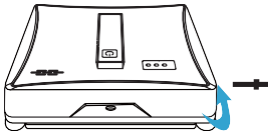

Figure1



Figure2

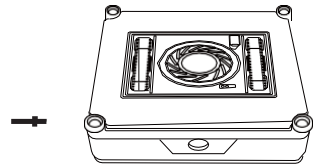

Figure3

Note: When installing the Cleaning Pad, be sure not to cover the anti-drop sensors placed on the four corners of the machine. The covering may cause the machine to fall. (Do not completely wet the pad).

2. Inject water

- A. Please do not add any other cleaning agents to the water tank.
- B. Turn the machine over, open the silicone cover, and add clean and impurities free water.
- C. Do not fill the water tank with water (80% is sufficient) to maintain stable air pressure.



Open the silicone cover.

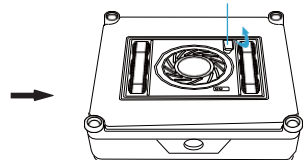

3. Connect the main unit power cord, adapter and plug

- A. Insert the DC connector (connector A) into the power interface of the machine, and tighten the nut. (Figure1).
- B. Connect the DC plug (connector B) to the adapter. (Figure2).
- C. Connect the power supply.(Figure3).

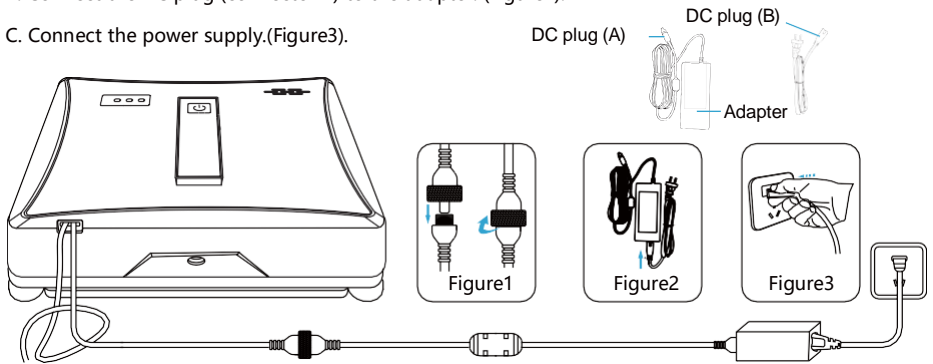

4. Connect and fix the safety rope

- A. Check that the safety rope is not broken and the connection with the robot is firm. (Figure1)
- B. Fix the other end of the safety rope on other objects in the room to ensure that the tightening will not cause the robot to drop or fall off. (Figure 2)

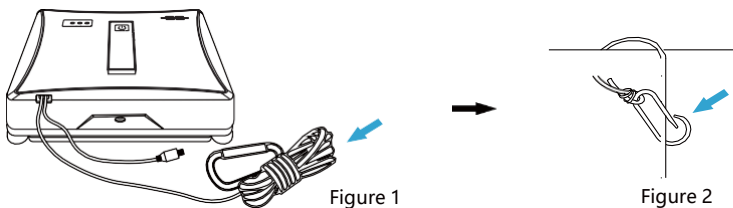

5. Start the robot

- A. Press and hold the "⏻" button for 2 seconds to turn on the machine
- B. Place the machine on the glass surface to be cleaned and press the "⏻" button again to start the cleaning program.

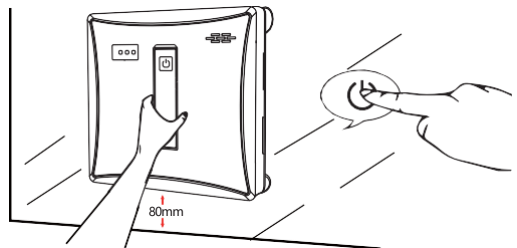

Warning: Before starting, please make sure that the four sides of the machine are at least 80mm away from the glass frame or the corners of the window.

4. Cleaning Function

1. Cleaning mode

Select the three cleaning mode on the remote control to completely clear the window.

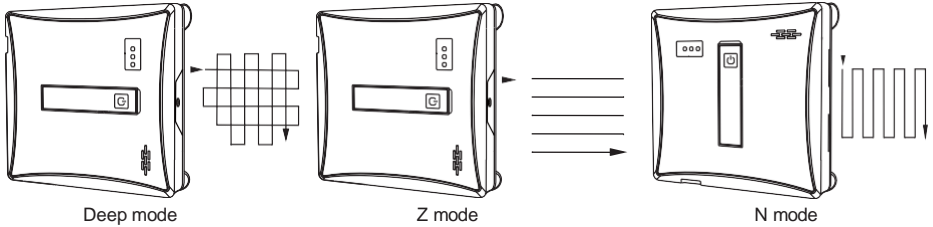

2. Water spray mode

Window cleaning robot set two water holes, when the robot to the left cleaning, the left side spray water, when the robot to the right cleaning, the right side spray water when the robot to the down cleaning the down side spray water.

- A. Automatic spraying mode: When the window cleaning robot is in the "Z" cleaning mode, the automatic spraying mode will be started by default, and the intermittent automatic spraying will be started.
- B. Press the **AU** button on the remote control to make the sound of "beep" and the automatic sprinkler mode is off. Press the **AU** button on the machine remote control to make two sounds of "beep beep" and the automatic sprinkler mode is on.
- C. When the window cleaning robot is in the "Z" shape cleaning mode, the machine is in the forward direction, press the **W** button of the remote control, the manual water spray mode is turned on, and press once to spray

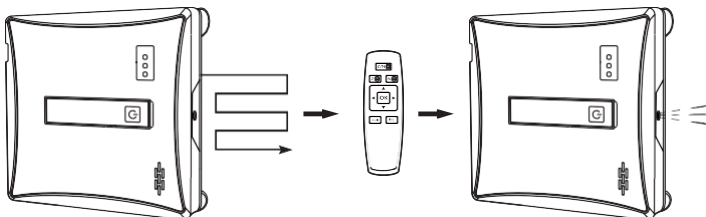

3. Fixed-point cleaning mode

- A. Press the upper, lower, left and right direction keys on the remote control to move the machine to the key cleaning position.
- B. Press the OK key on the remote control for 2 seconds to enter the fixed point cleaning.

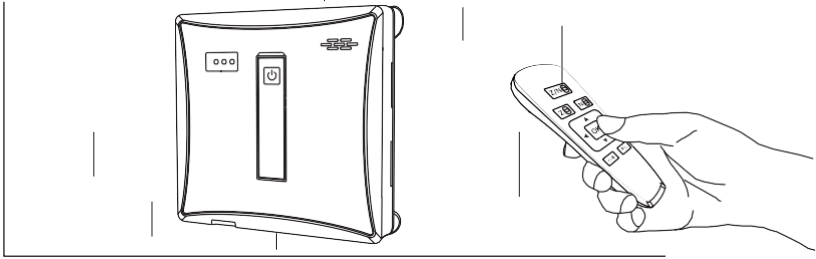

4. Power-off protection (UPS) function

- A. In case of power failure, the device will start the built-in backup battery power, which can last for 40 minutes (when the battery is fully charged).
- B. In case of power failure, the window cleaning robot will stay in the same place and will not move forward, and will give a warning sound and the red / blue lights will flash alternately. At this time, the user should withdraw the machine as soon as possible to avoid falling down due to power off.
- C. The safety rope can be used to gently pull back the device; when pulling the safety rope, it should be close to the glass as far as possible to avoid falling

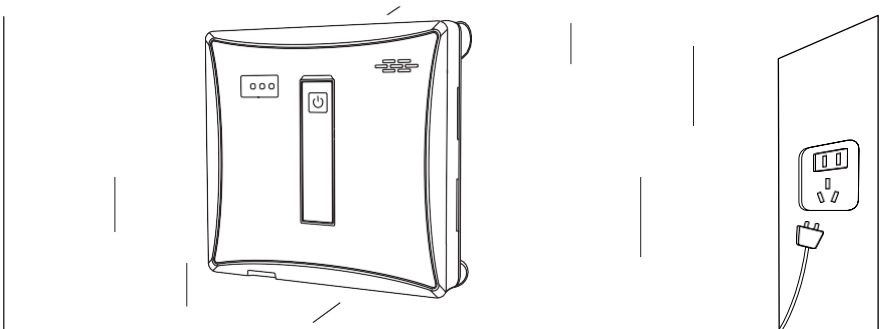





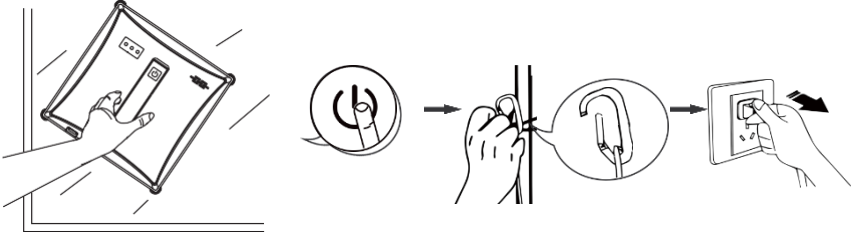





5. Cleaning completed

- A. After the robot is cleaned, it will stop at the starting point, hold the handle tightly, press and hold the " ⏻ " button for 3 seconds, the fan will stop working, and remove the host.
- B. Unfasten the safety rope and buckle.
- C. Disconnect power.



5. Remote control

- A. Do not charge the remote control battery, do not disassemble the battery, do not put the battery in fire, there is a possibility of detonation.
- B. Please use No. , AAA/RL batteries of the same specification as required, please do not use different types of batteries, there is a danger of burning the circuit, when the battery is installed and removed, push the remote control cover down, open the battery cover, and install .When using the battery, align the negative pole with one end of the spring first, press it down, the reverse installation of the battery is invalid, and then cover the battery cover.
- C. New and old batteries or different models, different types of batteries cannot be mixed.

	Z and then N-path automatic cleaning mode		Manual upward movement	
	Z-path automatic cleaning mode		Manual downward movement	
	N-path automatic cleaning mode		Manually move right	
	Automatic water spray		Manual move left	
	Manual water spray		fixed point cleaning	

6. Voice assistance function

serial number	Operate	Voice content
Window cleaning machine host voice function		
1	Boot prompt sound	Welcome to use our window cleaning robot, please tie the safety rope before starting. Do not use it in rainy and wet weather!
2	Window wipe machine power cord connection	Please connect the power cable
3	Start working	Please press the start button to start
4	Insufficient water in water tank	Insufficient water in water tank
Remote control voice function		
5	Remote control-Z	Start horizontal routes cleaning
6		horizontal routes cleaning mission complete
7	Remote control-N	Start vertical routes cleaning
8		vertical routes cleaning mission complete
9	Remote control-Z/N	Start deep cleaning
10		Deep cleaning mission complete
11	Remote control-automatic water-spray system AU	Start auto spray function
12		Close auto spray Function
13	Remote control-Manual water spray	Spray
14	Remote control- up	UP
15	Remote control-down	Down
16	Remote control-Left	Left
17	Remote control-Right	Right
18	Remote control-OK	Began to positioning cleaning
19		finish to positioning cleaning

7. Tuya App Operation Guide



1. Open the App store your phone.
2. Search for "Tuya" App.
3. Click to download and install.



4. Click to open the "Tuya" App.
5. Click on "Agree".

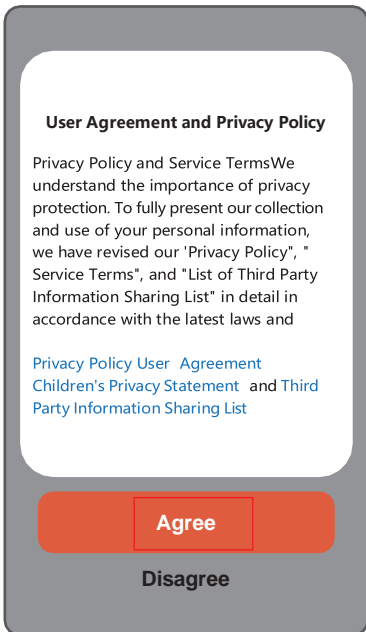

6.Type " ✓ " and then click "Click Login"

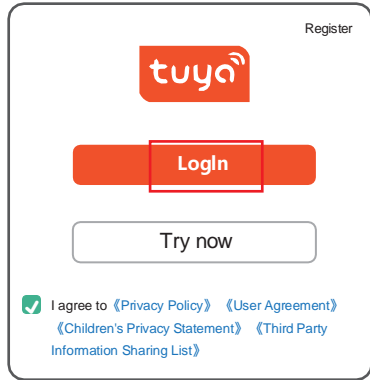

7. Turn on Bluetooth:
The robot connects power and open the bluetooth on smart phone
8. Click on "Add Device":
Make sure your device has entered pairing mode



9. Click on " Done "

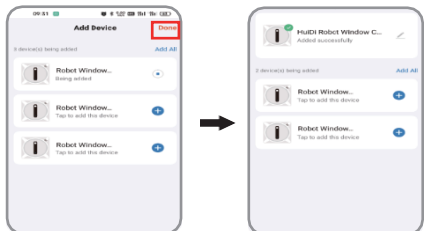

10. (1) Click "window cleaning robot" (2) Click " ⏻ " to start the robot

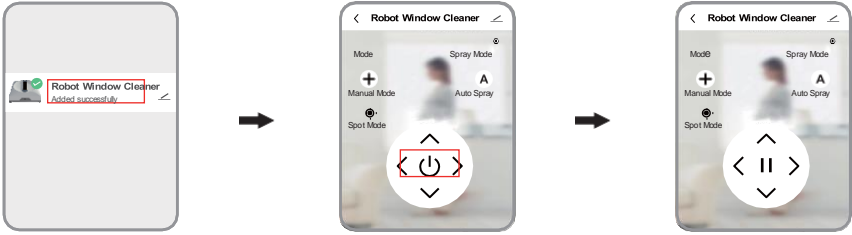

11. Click on Control panel to enter clean mode +

Clean mode:

+ Manual mode

N ⊗ N Mode

Z ⊗ Z Mode

Z/N ⊗ Right Mode

⊗ Spot Mode

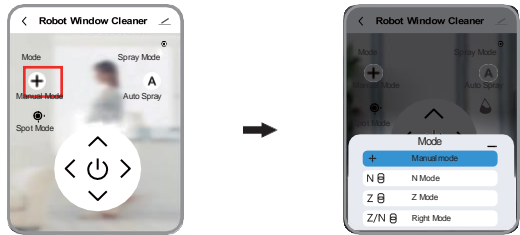

12. Click on the control panel to enter the water spray mode A

Water spray mode:

A Automatic Water Spray Mode

M Manual Spray Mode

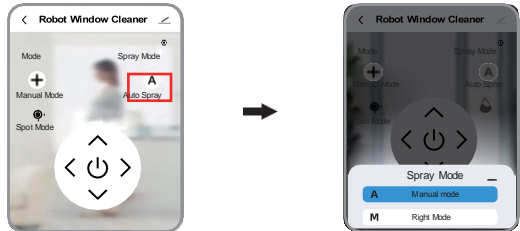

13. Click on the Control panel to access the Speech language selection

Speech language selection:

Chinese

English

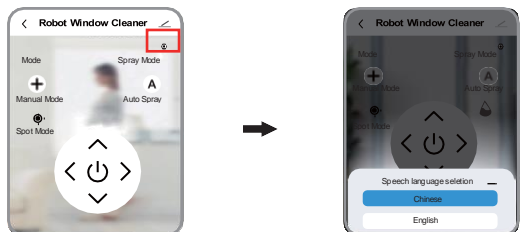

8. Product Maintenance

1. Maintenance of cleaning cloth

Please turn the body of the robot over and lay it flat and remove the pad, put it in cold water, add a small amount of detergent to clean it, wash it with clean water, and dry it

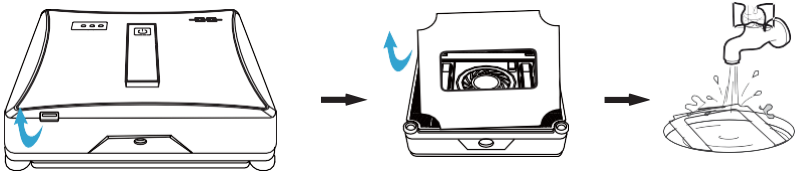

Note: Please do not use a completely drenched cloth to clean the windows. This may make your machine stuck on the glass surface due to excessive moisture and cannot be moved

2. Frameless anti-drop sensor maintenance

Please turn robot over and lay it flat, then use a clean wipe off any dust and other dirt from the frameless anti-drop sensor the robot.

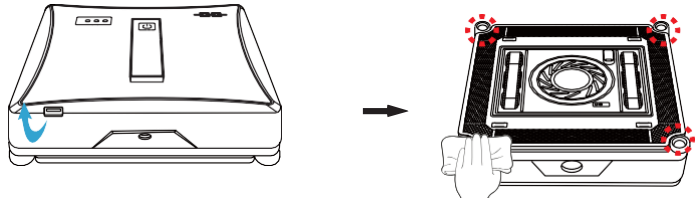

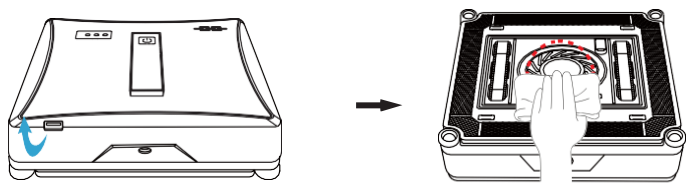

3. Fan maintenance

Please turn robot over and lay it flat, then use a clean wipe off any dust and other dirt from the fan the robot.



4. Walk-drive track maintenance

Please turn your robot body over and lay it flat and wipe the dust and other dirt from the drive track table with a clean dry cloth.

- A. The machine is connected to the power (no need to press the  key to start the machine).
- B. Long press the remote control up  and turn the machine into track cleaning
- C. Wipe the dust and stains on the belt surface with a wet towel.
- D. Release the  key on the remote control to exit the track cleaning mode.

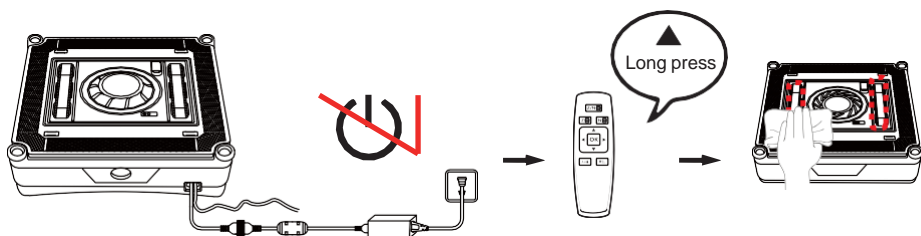

5. Window cleaning robot does not spray water

- A. Please confirm whether the water spray function switch is turned on.
- B. Clean the Atomizing plate nozzle with a clean soft cloth.
- C. Please check whether there is water in the water tank, and whether the added water is clean and free of impurities.
- D. Do not fill the water tank with water (80% is enough) to keep the air pressure stable.

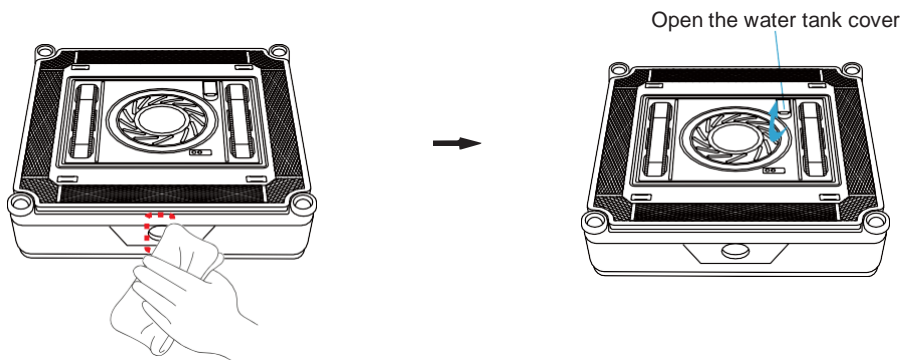

9. Troubleshooting

Fault status	Possible causes	The solution
Machine slippage.	Wiping cloth is too wet or the track is stained with water.	A. Replace the wiping cloth equipped with the machine. B. Dry the water on the tracks with a dry cloth. C. Clean the track wheel.
The machine is not running smoothly.	The glass is too wet or the glass surface with staining.	A. First use the remote control manually (up/down / left/right) in each direction to wipe the glass once, and then do further operations. B. Clean the track wheel.
During the operation of the machine, the top in Glass over the frame longer continue to clean.	The machine hit the edge of the current mis-judgement.	A. Use the remote control to manually remote control to a convenient operating position, and then do further operations. B. If the remote control is still unable to remote control the action, lightly pull the safety rope to manually move the machine to a convenient operating position.
Blue light and red light is always on buzzer does not sound.	The machine is not attached to the glass.	The machine is not attached to the glass.
The buzzer sounds two times in a row during the operation of the machine.	The machine probes the edge of the outside sensor senses the signal to move out of the glass edge frame	Ignore
Squeaking noise between the machine and the glass during operation	Anti-drop sensor dust too much dust accumulation in the track wheel too much.	A. Spray water to the glass surface or wipe the cloth B. Clean off the dust attached to the anti drop sensor C. Clean the crawler wheel.
The machine has not stopped at the starting position of the machine after the wiping action.	The friction force of each area of the wiped glass surface is different.	Attaching the machine to the glass surface.
The machine stops at a certain position in the process of operation, and the red light flashes.	Insufficient vacuum.	Check whether the wiping cloth is installed correctly
The machine cannot be started or the machine does not operate according to the preset path rules during operation.	The anti-drop sensor is abnormal and the track wheel accumulates too much dust.	A. Check whether the wipe is installed correctly. B. The anti-drop sensor is damaged. C. Clean the track wheel.
Blue light red light flashing, blue light does not light the buzzer continues to buzz.	Power supply power failure.	Check whether the power supply is disconnected or the machine power input Interface extension cable interface for poor contact (tightening nut is not tightened).
blue light red light flashing buzzer continuous interval of 1second second three.	Abnormal walking motor.	Contact after-sales service.
Tuya APP cannot search for the robot	Factory Settings were not restored	Press the (U) button on the machine for 3 times to restore factory Settings

* If the machine still cannot operate normally according to the manual, please contact my after-sales service staff for help

